



GUARDIAN™ 2000

Hotplate Stirrers



Rugged and Reliable Analog Hotplates and Stirrers for General Purpose Heating and Stirring

Dependable OHAUS Guardian 2000™ Hotplates and Stirrers are ideal for education and other lab environments that require affordable, everyday fast heating and reliable stirring up to 15L. All three sizes offer simple knob control to easily adjust the heating and stirring functions. The durable housing includes a built-in support rod holder which accepts the optional support rod. Stirring models include PTFE coated stir bars.

Unique Features:

- Powerful stirring and fast heating at an economical price. Safely heat up to 500°C and stir up to 15L with easy to use knob control for simple and reliable everyday heating and stirring in the lab.
- Designed to last - the rugged metal housing has a spill resistant design for long life in the lab under harsh conditions. The smooth, chemical-resistant ceramic top plate is perfect for easy clean up.
- Safety is of utmost importance - the prominent hot top indicator light illuminates when the heater is above 40°C, keeping the end user safe during all heating applications.

GUARDIAN™ 2000 Hotplate Stirrers

Specifications

Model	e-G21ST04R	e-G21HP04C	e-G21HS04C
Function	Stirring	Heating	Heating and Stirring
Top Plate Size	4 x 4 in / 10.2 x 10.2 cm		
Speed Range	200 - 1600 rpm	–	200 - 1600 rpm
Temperature Range	–	70 °C - 500 °C	
Control	Analog		
Capacity	15 L		
Top Plate Material	Resin	Ceramic	
Dimensions (H x L x W)	4.3 x 10.4 x 6.4 in / 11.0 x 26.4 x 16.3 cm		
Net Weight	4.7 lb. / 2.1 kg	4.0 lb. / 1.8 kg	5.5 lb. / 2.5 kg
Power	100V-120V ~2A 50/60Hz 220V-240V ~1A 50/60Hz	100V-120V ~5A 50/60Hz 220V-240V ~4A 50/60Hz	
Power Consumption	35W (100~120V) / 35W (220~240V)	505W (100~120V) / 505W (220~240V)	535W (100~120V) / 535W (220~240V)
Working Environment	41 °F – 104 °F, 80 % RH, non-condensing / 5 °C – 40 °C, 80 % RH, non-condensing		

Model	e-G21ST07R	e-G21HP07C	e-G21HS07C
Function	Stirring	Heating	Heating and Stirring
Top Plate Size	7 x 7 in / 17.8 x 17.8 cm		
Speed Range	200 - 1600 rpm	–	200 - 1600 rpm
Temperature Range	–	70 °C - 500 °C	
Control	Analog		
Capacity	15 L		
Top Plate Material	Resin	Ceramic	
Dimensions (H x L x W)	4.4 x 12.5 x 8.8 in / 11.2 x 31.8 x 22.3 cm		
Net Weight	6.2 lb. / 2.8 kg	7.1 lb. / 3.2 kg	8.6 lb. / 3.9 kg
Power	100V-120V ~2A 50/60Hz 220V-240V ~1A 50/60Hz	100V-120V ~10A 50/60Hz 220V-240V ~7A 50/60Hz	
Power Consumption	35W (100~120V) 35W (220~240V)	1005W (100~120V) 1005W (220~240V)	1035W (100~120V) 1035W (220~240V)
Working Environment	41 °F – 104 °F, 80 % RH, non-condensing / 5 °C – 40 °C, 80 % RH, non-condensing		

Model	e-G21STRDS	e-G21HPRDS	e-G21HSRDS
Function	Stirring	Heating	Heating and Stirring
Top Plate Size	5.3 in diameter / 13.5 cm diameter		
Speed Range	200 - 1600 rpm	–	200 - 1600 rpm
Temperature Range	–	50 °C - 380 °C	
Control	Analog		
Capacity	15 L		
Top Plate Material	Ceramic Coated Stainless Steel		
Dimensions (H x L x W)	4.0 x 10.4 x 6.4 in / 10.1 x 26.4 x 16.3 cm		
Net Weight	5.1 lb. / 2.3 kg	4.0 lb. / 1.8 kg	5.5 lb. / 2.5 kg
Power	100V-120V ~2A 50/60Hz 220V-240V ~1A 50/60Hz	100V-120V ~5A 50/60Hz 220V-240V ~4A 50/60Hz	
Power Consumption	35W (100~120V) 35W (220~240V)	505W (100~120V) 505W (220~240V)	535W (100~120V) 535W (220~240V)
Working Environment	41 °F – 104 °F, 80 % RH, non-condensing / 5 °C – 40 °C, 80 % RH, non-condensing		

GUARDIAN™ 2000 Hotplate Stirrers

Specifications & Accessories

GUARDIAN 2000										
Application Modes	Boiling Liquids, Basic Sample and Solution Preparation, Dissolving Buffers and Reagents, Preparing Media, Concentrating Samples									

Item No.	Description	e-G21ST04R	e-G21HP04C	e-G21HS04C	e-G21ST07R	e-G21HP07C	e-G21HS07C	e-G21STRDS	e-G21HPRDS	e-G21HSRDS
30500597	Vessel Clamp	●	●	●	●	●	●	●	●	●
30500598	Stir Bar Retriever	●		●	●		●	●		●
30400147	Spinbar 2.5 cm PTFE	●		●	●		●	●		●
30400148	Spinbar 3.8 cm PTFE	●		●	●		●	●		●
30400149	Spinbar 7 cm PTFE	●		●	●		●	●		●
30400150	Spinbar 10 cm with Pivot Ring PTFE	●		●	●		●	●		●
30692826	Holder Kit Thermometer e-G31		●	●		●	●		●	●
30726783*	Spinbar with a Pivot 3.8 cm PTFE	●		●	●		●	●		●

* 3076783 is a pack of 5 spinbars



GUARDIAN™ 2000 Hotplate Stirrers

Outline Dimensions

e-G21HS04C, e-G21HP04C, e-G21ST04R

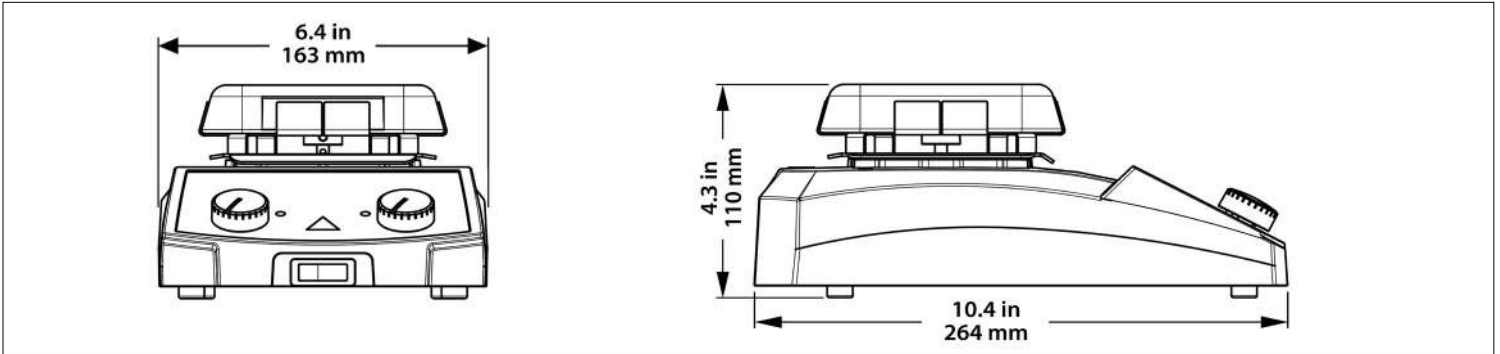

e-G21HSRDS, e-G21HPRDS, e-G21STRDS

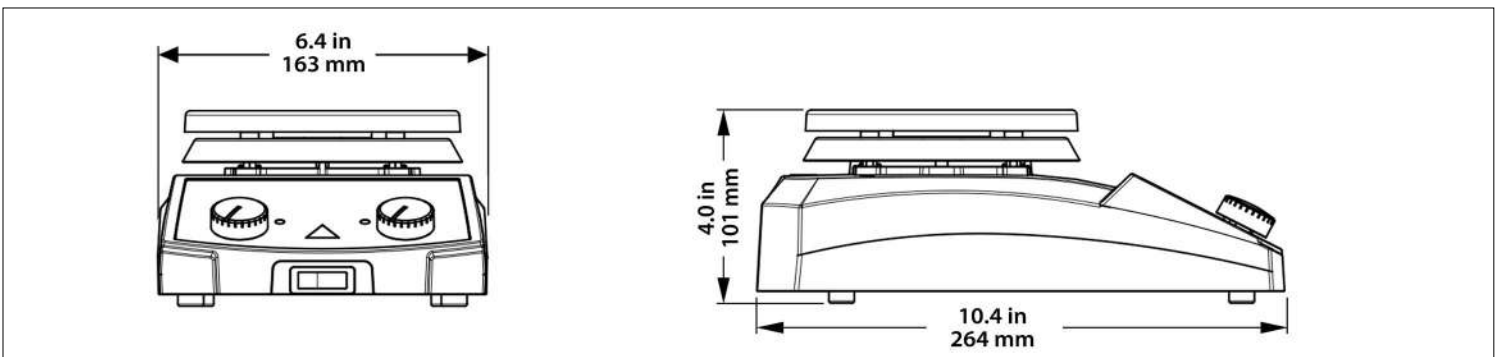

e-G21HS07C, e-G21HP07C, e-G21ST07R

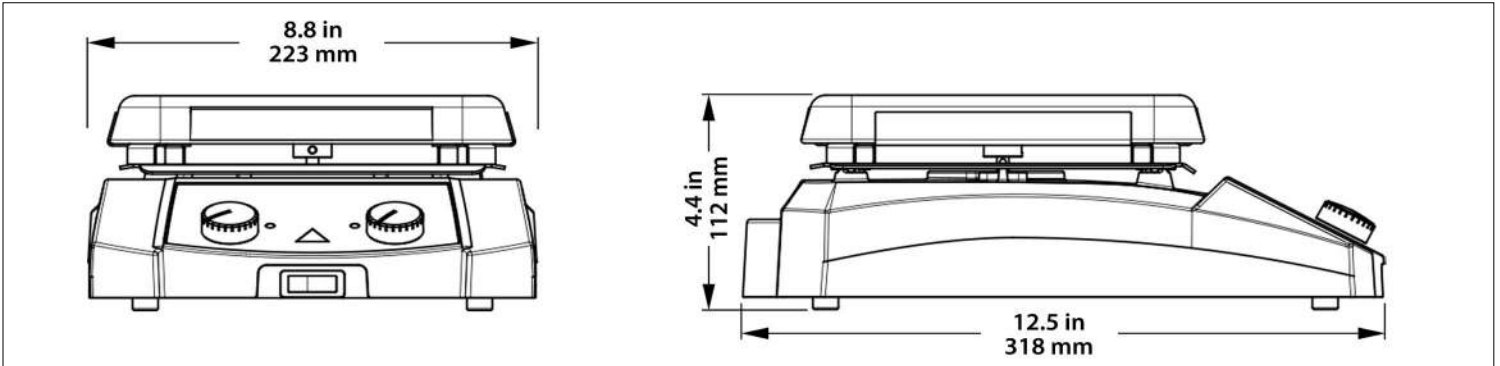

Other Features and Equipment

Green indicator lights when unit is heating and stirring with simple control knobs for easy temperature and speed adjustments, two PTFE coated stir bars (included with stirring models), ON/OFF switch for heater disconnect, built-in support rod holder

Compliance

- **Product Safety:** CE, TUV, TÜV SÜD certified to CAN/CSA C22.2 61010-1; CAN/CSA C22.2 61010-2-010; CAN/CSA C22.2 61010-2-051; UL 61010-1; UL 61010-2-010; UL 61010-2-051
- **Electromagnetic Compatibility:** Canada ICES-003 Class A; FCC Part 15 Class A
- **Other:** IP21

OHAUS CORPORATION

7 Campus Drive
Suite 310
Parsippany, NJ 07054 USA

Tel: 800.672.7722

973.377.9000

Fax: 973.944.7177

www.ohaus.com

The management system governing the manufacture of this product is ISO 9001:2015 certified.

